

# Blum

ref. **BL06**

Wall sconce

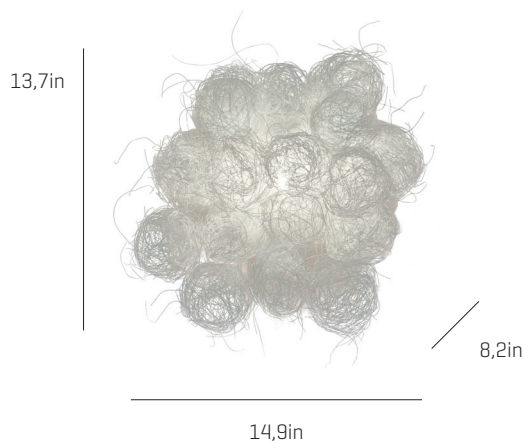

## Blum Collection



BL04



BL06

### MATERIAL FINISHES

#### LAMPSHADE

Painted stainless steel thread

One color



#### SUPPORT

Painted steel

#### MOUNTING OPTIONS

Wall sconce

### RECOMMENDED BULBS

#### 120V - 60Hz

 E26 Med. - Max. 1x100 W

 E26LED - Max. 1x13 W

### OTHER TECHNICAL DATA

#### NET WEIGHT

2,4lb

#### PACKAGING

17x17x11,8in

3,3lb

#### ELECTRICAL FEATURES



#### CERTIFICATIONS



# Blum

ref. **BL06**

Suitable for indoor use, at 77°F

Apta para uso interior a temperatura ambiente de 77°F

Box contains | Contenido de la caja:

**A** - Lampshade | Tulipa [1]

**B** - Holding piece | Pieza de sujeción [1]

**C** - Security screws | Tornillos de seguridad [2]

**D** - Canopy | Florón [1]

**E** - Electrical disposal | Ficha [3]

**F** - Screws | Tornillos [2]

**G** - Wall Plugs | Tacos [2]

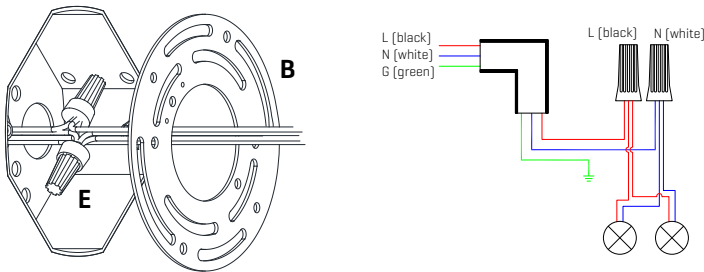
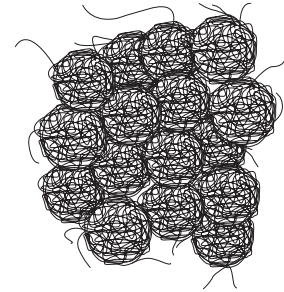

## 1

Pass the electric cables to the interior and do the electric connection inside the octagon box, please follow the instructions.

Passar los cables eléctricos al interior y hacer la conexión eléctrica dentro de la caja de conexiones, siguiendo las instrucciones.

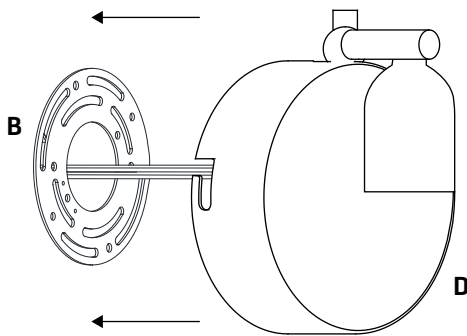

## 2

Fit the shade in the base, turn it until it reaches the end stop by inserting the fixing screws to the slots of the canopy. Tighten the fillet of the fixing screws to fasten the whole set.

Encajar la tulipa en el soporte, girándola hasta que haga tope al introducir los tornillos de enganche en las ranuras del florón. Apretar la rosca de los tornillos de enganche para asegurar el conjunto.

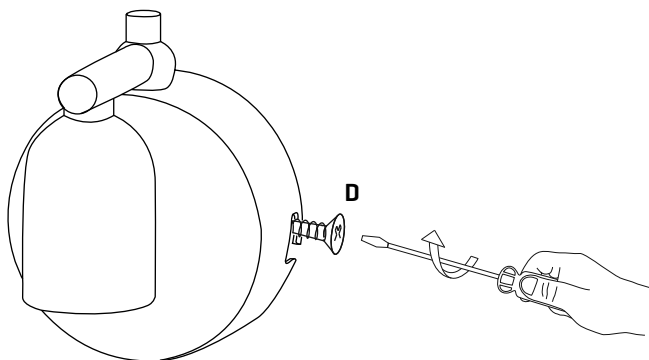

## 3

Join the shade to the base, by screwing a pair of screws on each side.

Unir la tulipa en el soporte, atornillando la pareja de tornillos de cada lado.



The device is not suitable for installation on normally inflammable surfaces.

Aparato no adaptado para la instalación en superficies normalmente inflamables.



4

Unscrew the cap placed on top for the placement of the lampshade.

Desenroscar el tapón situado en la parte superior para la colocación de la tulipa.

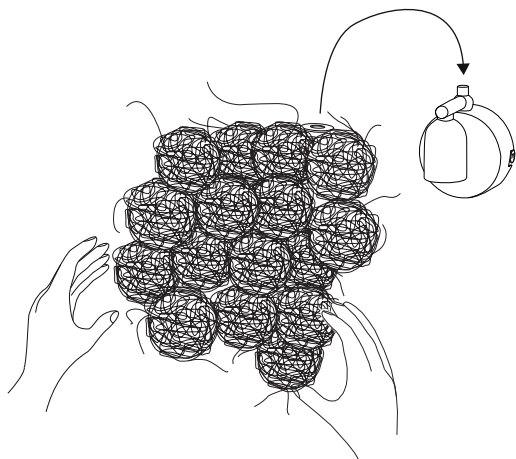

5

Fit it the lampshade on the canopy, as shown in illustration.

Encajar la tulipa en el florón como se muestra en la ilustración.

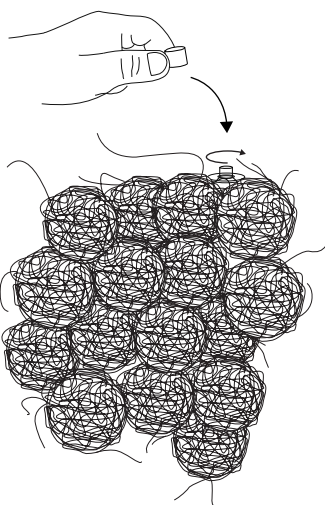

6

Screw the previously removed cap which will hold the tulip.

The lamp should be treated carefully. Occasionally holding of the lampshade with strength may modify its original desing. To solve it, open the lampshade and mold with your hands all the crushed parts so that they rever their original shape.

Roscar el tapón anteriormente retirado que sujetará la tulipa.

Debido a la flexibilidad del material, al manejar la tulipa se puede modificar su diseño original. Para solucionarlo, moldear con la mano las zonas dónde se aplaste para que vuelvan a su posición original.