

Vento

LED

ref. VN04- LD

LED / DIMMABLE

Pendant lamp

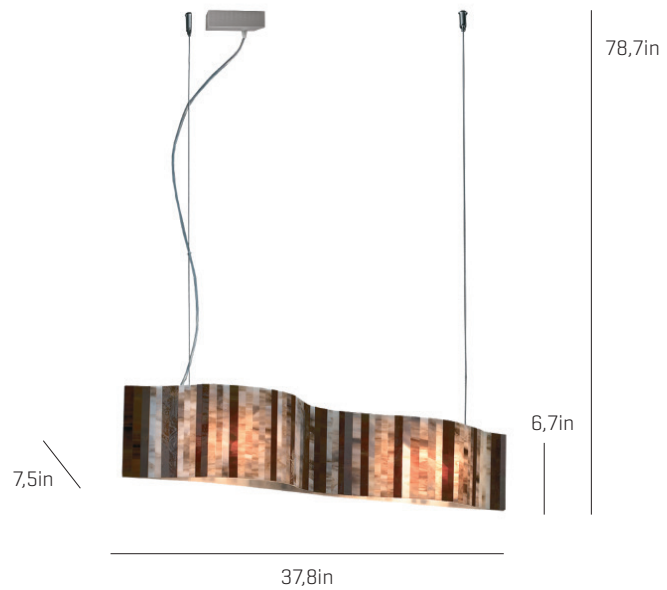

Vento Collection

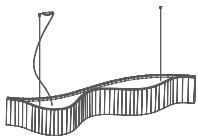

VN04-LD

MATERIAL FINISHES

LAMPSHADE

Glass

One color to choose

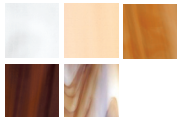

Color combinations
Brown



CANOPY AND CABLE

Stainless steel

Black or transparent

Bottom diffuser

LIGHT SOURCE BUILT IN

100 277V- 60Hz

□ □ □ □ 16W 2.125lm 3000K built-in

upon request 2700k Dimming

system 0-10 V

upon request PHASE CONTROL (only 120V)

OTHER TECHNICAL DATA

NET WEIGHT

12,3lb

PACKAGING

49,2x11,8x11,8in

21,6lb

ELECTRICAL FEATURES



CERTIFICATIONS



Vento

ref. VN04-LD

Suitable for indoor use, at 77°F
Apta para uso interior a temperatura ambiente de 77°F

Box contains | Contenido de la caja:

- | | |
|-------------------------------------|----------------------------|
| A - Electrical disposal Ficha [5] | E - Tie rod Tensor [2] |
| B - Canopy Florón [1] | F - Lampshade Tulipa [1] |
| C - Wall plugs Tacos [6] | |
| D - Screws Tornillo [6] | |

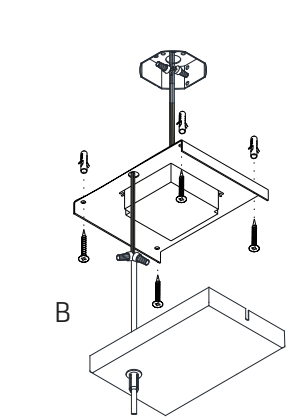
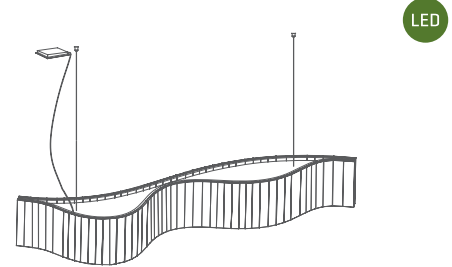

1.1

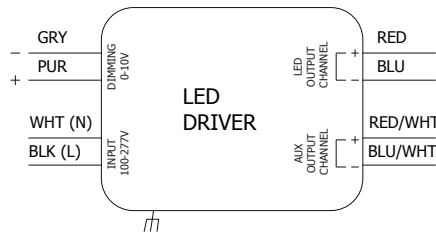

1.2

1

- 1.1 Drill the holes in the ceiling, fit the wall plugs into them and screw the holding piece.
- 1.2 Switch off the main electrical supply and do the electric connection, please follow the instructions.
- 1.3 The cables color RE/WHT and BLU/WHT has not usage in the lamp instalation. Put them into the octagon box with a wire conector in each one.

- 1.1 Realizar los agujeros en el techo, colocar los tacos y atornillar la pieza de sujeción.
- 1.2 Desconectar la corriente principal y hacer la conexión eléctrica siguiendo las instrucciones.
- 1.3 Los cables RE/WHT y BLU/WHT no se usan, porfavor ponerlo en la octagon box con una ficha de conexión en cada uno.

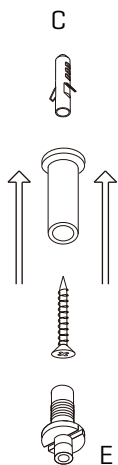

2.1

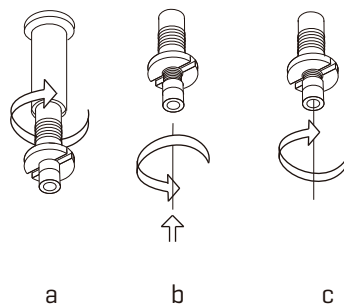

2.2

2

- 2.1. Drill the holes, fit the wall plugs into them and fix the metallic frame to the ceiling.
- 2.2. a) Screw the tie rod. b) Loosen the security nut and introduce the steel wire. c) Tighten the security nut. In order to remove the cable from the tension loosen the nut, to push it upwards and to throw of the cable.

- 2.1. Hacer los agujeros, colocar los tacos y fijar la pieza metálica al techo.
- 2.2. a) Enroscar el tensor. b) Aflojar la tuerca de seguridad e introducir el cable de acero. c) Apretar la tuerca de seguridad. Para sacar el cable del tensor aflojar la tuerca, empujarla hacia arriba y tirar del cable.

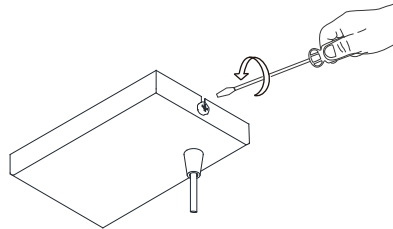
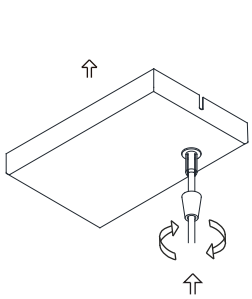

3

Insert the canopy in the holding piece and tighten the security screws. Tighten the strain relief situated on the canopy.

Encajar el florón en la pieza de sujeción y apretar los tornillos de seguridad. Apretar el tensor del cable situado en el florón.