

Kala

ref. **KL06**

Wall sconce

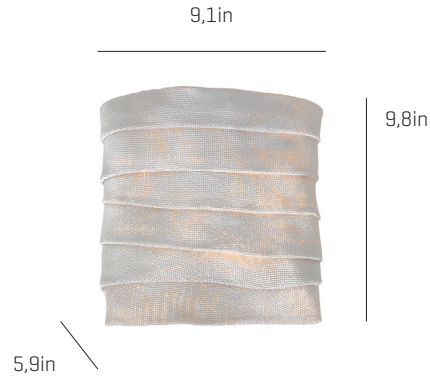

Kala Collection

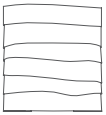

KL06

MATERIAL FINISHES

LAMPSHADE

Painted stainless steel

One colour to choose

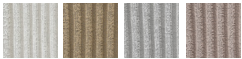

SUPPORT

Stainless steel

MOUNTING OPTIONS

Wall sconce

RECOMMENDED BULBS

120V - 60Hz

 G9 Bi - pin - Max. 2x40 W

OTHER TECHNICAL DATA

NET WEIGHT

1,3lb

PACKAGING

13,4x9,4x5,5in

2,2lb

ELECTRICAL FEATURES



CERTIFICATIONS



Kala

ref. KL06

Suitable for indoor use, at 77°F

Apta para uso interior a temperatura ambiente de 77°F

Box contains | Contenido de la caja:

A - Lampshade | Tulipa [1]

B - Holding piece | Pieza de sujeción [1]

C - Screws | Tornillos [2]

D - Security screws | Tornillos de seguridad [2]

E - Electrical disposal | Ficha [3]

F - Frame | Soporte [1]

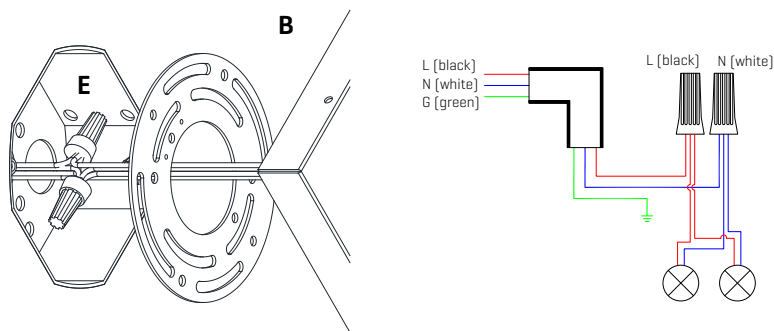
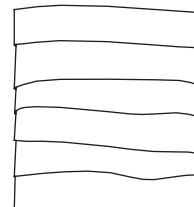

1

Pass the electric cables to the interior and do the electric connection, please follow the instructions.

Passar los cables eléctricos al interior y hacer la conexión eléctrica dentro de la caja de conexiones, siguiendo las instrucciones.

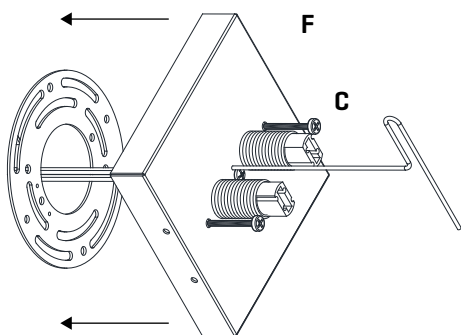

2

Fit the shade in the base, turn it until it reaches the end stop by inserting the fixing screws to the slots of the canopy. Tighten the fillet of the fixing screws to fasten the whole set.

Encajar la tulipa en el soporte, girándola hasta que haga tope al introducir los tornillos de enganche en las ranuras del florón. Apretar la rosca de los tornillos de enganche para asegurar el conjunto.

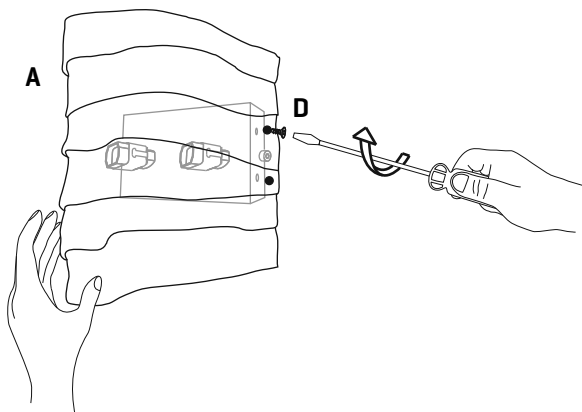

3

Join the shade to the base, by screwing a pair of screws on each side.

Unir la tulipa en el soporte, atornillando la pareja de tornillos de cada lado.



The device is not suitable for installation on normally inflammable surfaces.

Aparato no adaptado para la instalación en superficies normalmente inflamables.

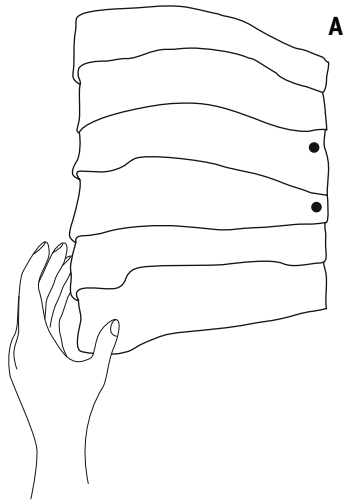

4

The lamp should be treated carefully. Occasionally holding of the lampshade with strength may modify its original desing. To solve it, open the lampshade and mold with your hands all the crushed parts so that they rever their original shape.

NOTA: The mesh should never be in contact with the bulbs.

Debido a la flexibilidad del material, al manejar la tulipa se puede modificar su diseño original. Para solucionarlo, moldear con la mano las zonas dónde se aplaste para que vuelvan a su posición original.

NOTA: La malla no debe estar en contacto con las bombillas.