

## Ballet Relevé

ref. **BARE04**

Pendant lamp



Ballet Collection

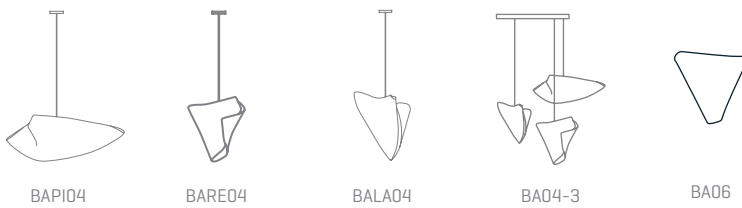

### MATERIAL FINISHES

#### LAMPSHADE

Painted stainless steel

One color to choose



Stainless steel

#### CANOPY AND CABLE

Steel gloss nickel-plated

Black or transparent cable

### RECOMMENDED BULBS

#### 120V - 60Hz

 E26 Med. - Max. 1x100 W

 E26 Med. - Max. 1x42 W

 E26LED - Max. 1x13 W

upon request:

 GU24 - Max. 1x23 W

### OTHER TECHNICAL DATA

#### NET WEIGHT

2,2lb

#### PACKAGING

17x17x11,8in

4,6lb

#### ELECTRICAL FEATURES



#### CERTIFICATIONS



## Ballet Relevé

ref. **BARE04**

Suitable for indoor use, at 77°F

Apta para uso interior a temperatura ambiente de 77°F

Box contains | Contenido de la caja:

**A** - Lampshade | Tulipa [1]

**B** - Holding piece | Pieza de sujeción [1]

**C** - Lampholder | Portalámparas [2]

**D** - Security screws | Tornillos de seguridad [2]

**E** - Electrical disposal | Ficha [2]

**F** - Canopy | Florón [1]

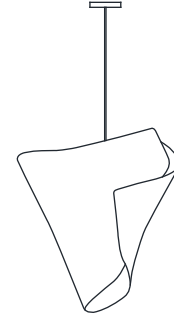

**ATTENTION!** The canopy is subject to one if the covers the box

**ATENCIÓN!** El florón va sujeto a una de las tapas de la caja.

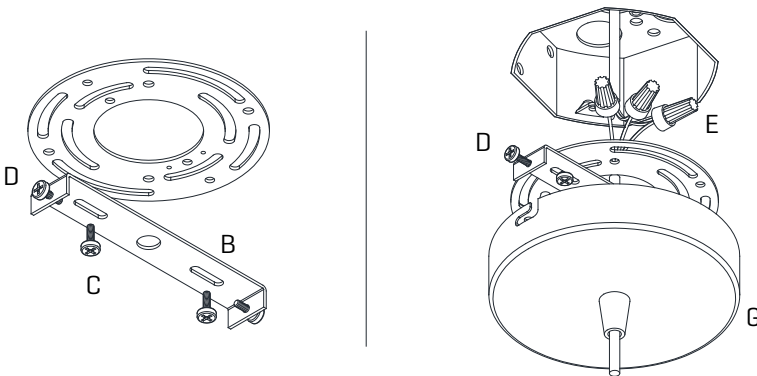

**1**

Pass the electric cables to the interior and do the electric connection inside the octagon box, please follow the instructions.

Pasar los cables eléctricos al interior y hacer la conexión eléctrica dentro de la caja de conexiones, siguiendo las instrucciones.

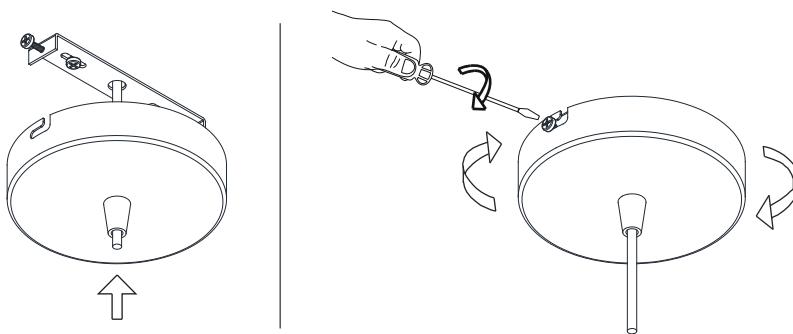

**2**

Insert the canopy in the holding piece and tight the security screws.

Tighten the strain relief situated on the canopy.

Encajar el florón en la pieza de sujeción y apretar los tornillos de seguridad.

Apretar el tensor del cable situado en el florón.

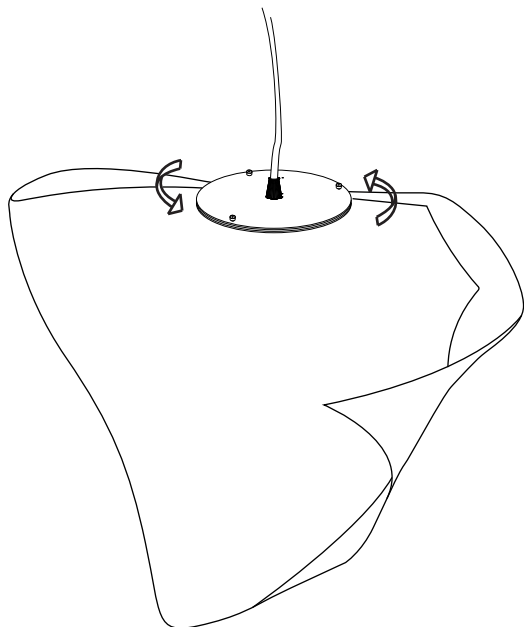

### 3

Place the light bulbs.  
[During this step, it is important to take greatest of care in this step, since holding of the lampshade with strength may modify its original design]

Slightly turn the lampholder.

Colocación de las bombillas.  
[Durante este paso, es importante tener el máximo cuidado, ya que al manejar la tulipa con demasiada fuerza se puede modificar su diseño original]

Girar levemente el soporte del portalámparas

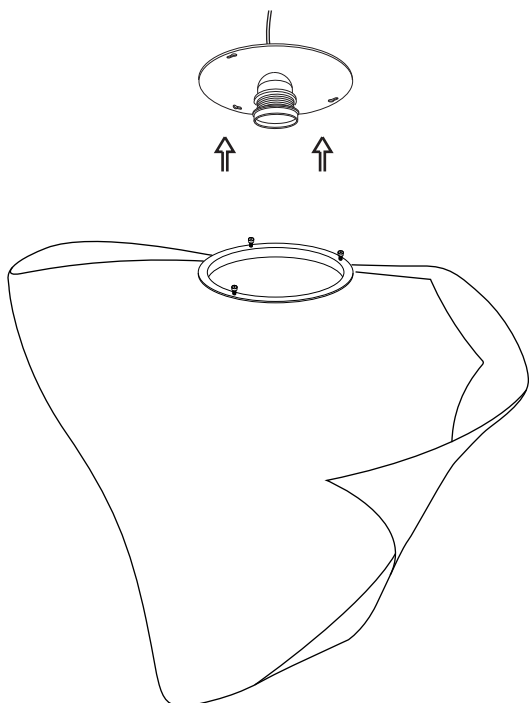

### 4

4. Separate the lampshade to the lampholder

4.1 Repeat the process in reverse once placed bulbs, fitting the lampshade in the diffuser [metal hoop] grooves and turn it until it reaches the endstop. Tight the screws to fasten the lampshade and the whole set.

NOTA: The mesh should never be in contact with the bulbs.

4. Separar la tulipa del portalámparas

4.1 Repetir el proceso a la inversa una vez colocadas las bombillas, encajando la tulipa en las rendijas del soporte y girando hasta que haga tope. Apretar los tornillos de enganche para asegurar el conjunto.

NOTA: La malla no debe estar en contacto con las bombillas.