

Ballet Plié

LED

ref. **BAPI04-LD**

LED / DIMMABLE

Pendant lamp

Lámpara colgante



Ballet Collection



MATERIAL FINISHES MATERIALES Y ACABADOS

LAMPSHADE

TULIPA

Painted stainless steel
Acero inoxidable pintado

One color to choose
Un color a elegir

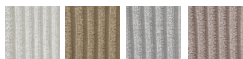

Stainless steel
Acero inoxidable

Inside diffuser
Difusor interior

CANOPY AND CABLE

FLORÓN Y CABLE

Steel gloss nickel-plated
Acero níquel-satinado

Black or transparent cable
Cable negro o transparente

LIGHT SOURCE BUILT IN FUENTE DE LUZ INCLUIDA

230V - 50Hz

Ⓢ 18,1W 3000K 1776lm built-in
upon request 2700K 1645lm

Dimming system: DALI / Switch DIM
upon request PHASE CUT

120V - 60Hz

Ⓢ 18,1W 3000K 1776lm built-in
upon request 2700K 1645lm

Dimming system: 0-10V
upon request PHASE CONTROL

ENERGY EFFICIENCY EFICIENCIA ENERGÉTICA

A+

OTHER TECHNICAL DATA OTROS DATOS TÉCNICOS

NET WEIGHT

PESO NETO

2,1kg | 4,6l

PACKAGING

EMBALAJE

61x61x33cm | 24x24x13in

4,3kg | 9,7lb

ELECTRICAL FEATURES

CARACTERÍSTICAS ELÉCTRICAS



CERTIFICATIONS

CERTIFICACIONES



Ballet Plié

ref. **BAPI04-LD**

Suitable for indoor use, at 25°C

Apta para uso interior a temperatura ambiente de 25°C

Box contains | Contenido de la caja:

A - Lampshade | Tulipa [1]

B - Holding piece | Pieza de sujeción [1]

C - Security screws | Tornillos de seguridad [2]

D - Wall Plugs | Tacos [2]

E- Canopy | Florón [1]

F- Screws | Tornillos [2]

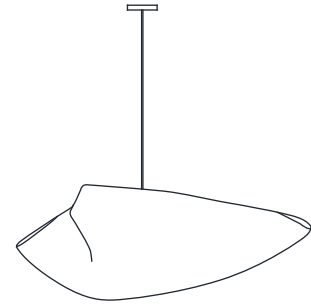

LED

SAFETY NOTE: Switch off mains supply before commencing installation

INDICACIÓN DE SEGURIDAD: Desconecte la alimentación eléctrica antes de empezar con la instalación

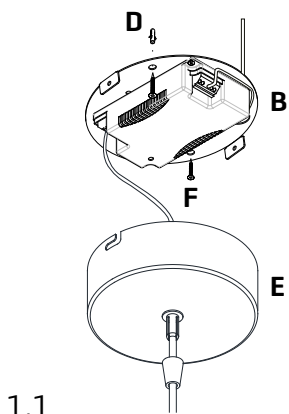

1.1

See the circuit diagram
on the back of this sheet

Ver diagrama de circuito en el
reverso del folio

1.2

1

1.1 Drill the holes in the ceiling, fit the wall plugs into them and screw the holding piece.
1.2 Do the electric connection, please follow the instructions.

1.1 Realizar los agujeros en el techo, colocar los tacos y atornillar la pieza de sujeción.
1.2 Hacer la conexión eléctrica siguiendo las instrucciones.

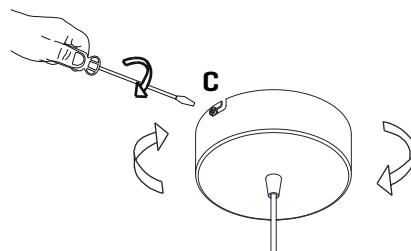
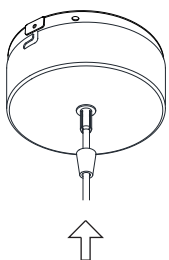

2

Insert the canopy in the holding piece and tight the security screws.
Tighten the strain relief situated on the canopy

Encajar el florón en la pieza de sujeción y apretar los tornillos de seguridad.
Apretar el tensor del cable situado en el florón.

220-240 V
0/50/60 Hz

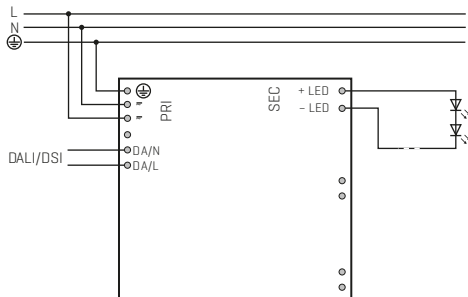

Circuit diagram DALI

220-240 V
0/50/60 Hz

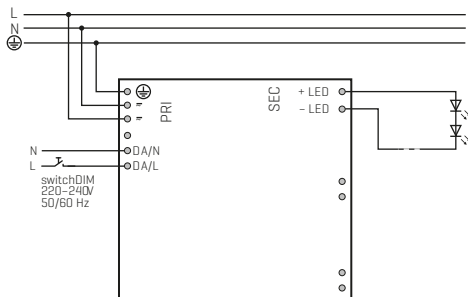

Circuit diagram DIMMABLE
SWITCH

220-240V
0/50/60 Hz

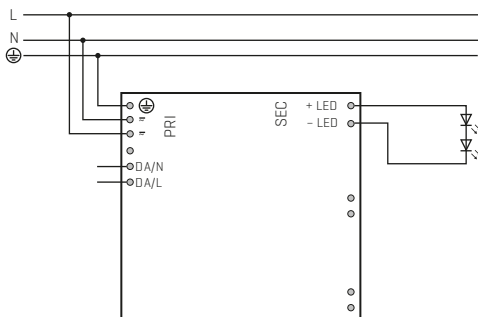

Circuit diagram NOT DIMMABLE

COLOR CODE:
CÓDIGO DE COLORES:

PHASE (L) - BLACK OR BROWN
FASE (L) - NEGRO O MARRÓN

NEUTRAL (N) - BLUE
NEUTRO (N) - AZUL

EARTHING (⊕) - GREEN AND YELLOW
TOMA TIERRA (⊕) - VERDE Y AMARILLO