

Arc

LED

ref. **AC02**

Table lamp
Lámpara de mesa

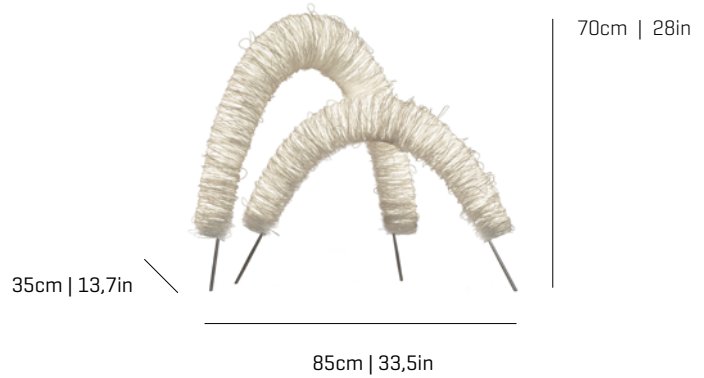

Arc Collection

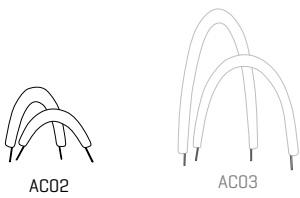

MATERIAL FINISHES MATERIALES Y ACABADOS

LAMPSHADE

TULIPA

Cord
Cordón

One color
Un color



SUPPORT AND CABLE

SOPORTE Y CABLE

Stainless steel
Acero inoxidable

Transparent cable
Cable transparente

LIGHT SOURCE FUENTE DE LUZ

230V - 50Hz

 STRIP 39,4W 3000K 2897lm built-in

120V - 60Hz

 STRIP 39,4W 3000K 2897lm built-in

ENERGY EFFICIENCY EFICIENCIA ENERGÉTICA

from A++ to A
desde A++ a A

OTHER TECHNICAL DATA OTROS DATOS TÉCNICOS

PACKAGING

EMBALAJE

71x71x40 cm | 28x28x16 in
10kg | 22lb

ELECTRICAL FEATURES

CARACTERÍSTICAS ELÉCTRICAS



CERTIFICATIONS

CERTIFICACIONES



Transport not included, price upon request
Precio no incluido, consultar precio.

Arc

ref. **AC02**

Suitable for indoor use, at 25°C

Apta para uso interior a temperatura ambiente de 25°C

Box contains | Contenido de la caja:

A - Arc 1 | Arco 1 [1]

B - Arc 2 | Arco 2 [1]

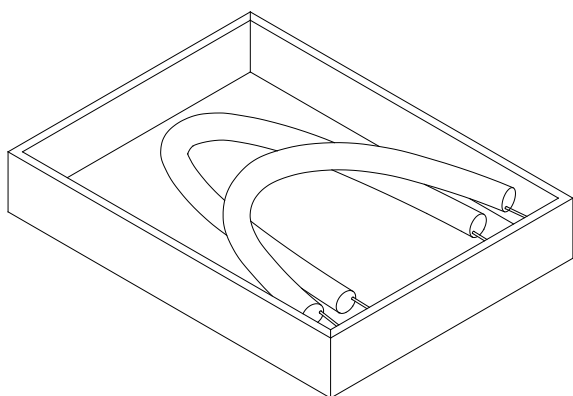
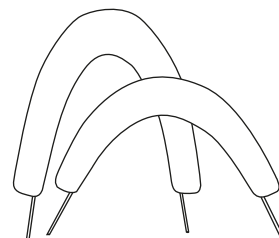

1

IMPORTANT!

Careful handling of the lamp, both arcs are electrically connected.

Remove the both arcs at the same time, not separate.

¡IMPORTANTE!

Cuidado con la manipulación de la lámpara, los arcos están unidos eléctricamente.

Sacar los dos arcos al mismo tiempo, no separarlos.

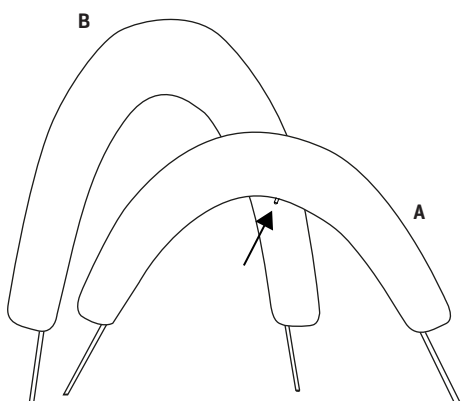

2

Connect the table lamp to the mains electrical supply line and turn on the switch, which is located at the bottom of the arc A.

Conecte la luminaria a la red eléctrica y encienda el interruptor, el cual está situado en la parte inferior del arco A.